

Features

- High isolation 3750 VRMS
- CTR flexibility available see order information
- DC input with transistor output
- Operating temperature range - 40 °C to 110 °C
- REACH compliance
- Halogen free
- MSL class 1
- Regulatory Approvals
 - UL - UL1577
 - VDE - EN60747-5-5(VDE0884-5)
 - CQC - GB4943.1

Applications

- Switch mode power supplies
- Programmable controllers
- Household appliances
- Office equipment

Description

The ICPL-357 series combine an AlGaAs infrared emitting diode as the emitter which is optically coupled to a silicon planar phototransistor detector in a plastic SOP4 package.

With the robust coplanar double mold structure, ICPL-357 series provide the most stable isolation feature.

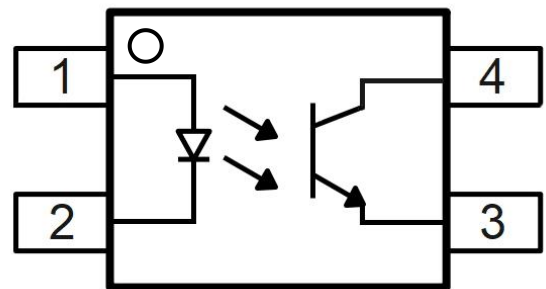

ORDERING INFORMATION

Outline	Part Number	Package	Marking	Packing	Packing Size	Quantity
	ICPL-357-500E	SOP4	ICPL 357X /YYWW A	Reels	13 "	3000
	ICPL-357-50AE					
	ICPL-357-50BE					
	ICPL-357-50CE					

CONTENTS

Pin Configuration And Functions.	3
Absolute Maximum Ratings.	3
Electrical Optical Characteristics.	4
Characteristic Curves.	5
Test Circuits.	7
Package Dimensions	8
Recommended Solder Mask	8
Carrier Tape Specifications	9
Ordering And Marking Information	10
Reflow Information	11
Temperature Profile Of Soldering.	12
Disclaimer	13

PIN CONFIGURATION AND FUNCTIONS

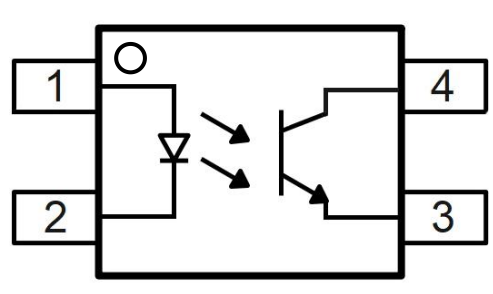
	Pin	Name
	1	Anode
	2	Cathode
	3	Emitter
	4	Collector

ABSOLUTE MAXIMUM RATINGS

Parameter	Symbol	Value	Unit	Note
INPUT				
Forward Current	I_F	60	mA	
Peak Forward Current	I_{FP}	1	A	1
Reverse Voltage	V_R	6	V	
Input Power Dissipation	P_I	100	mW	
OUTPUT				
Collector - Emitter Voltage	V_{CEO}	80	V	
Emitter - Collector Voltage	V_{ECO}	7	V	
Collector Current	I_C	50	mA	
Output Power Dissipation	P_O	150	mW	
COMMON				
Total Power Dissipation	P_{TOT}	200	mW	
Isolation Voltage	V_{iso}	3750	Vrms	2
Operating Temperature	T_{opr}	-40~110	°C	
Storage Temperature	T_{stg}	-55~125	°C	
Soldering Temperature	T_{sol}	260	°C	

Note 1. 100µs pulse, 100Hz frequency

Note 2. AC For 1 Minute, R.H. = 40 ~ 60%

ELECTRICAL OPTICAL CHARACTERISTICS (T_a=25°C)

Parameter	Symbol	Min	Typ.	Max.	Unit	Test Condition	Note	
INPUT								
Forward Voltage	V _F	-	1.24	1.4	V	I _F =10mA		
Reverse Current	I _R	-	-	10	uA	V _R =6V		
Input Capacitance	C _{in}	-	10	-	pF	V=0, f=1kHz		
OUTPUT								
Collector Dark Current	I _{CEO}	-	-	100	nA	V _{CE} =20V, I _F =0		
Collector-Emitter Breakdown Voltage	BV _{CEO}	80	-	-	V	I _C =0.1mA, I _F =0		
Emitter-Collector Breakdown Voltage	BV _{ECO}	7	-	-	V	I _E =0.1mA, I _F =0		
TRANSFER CHARACTERISTICS								
Current Transfer Ratio	A	CTR	80	-	160	%	I _F =5mA, V _{CE} =5V	
	B		130	-	260			
	C		200	-	400			
	None		80	-	400			
Collector-Emitter Saturation Voltage	V _{CE(sat)}	-	0.06	0.2	V	I _F =20mA, I _C =1mA		
Isolation Resistance	R _{ISO}	10 ¹²	10 ¹⁴	-	Ω	DC500V, 40 ~ 60% R.H.		
Floating Capacitance	C _{IO}	-	0.4	1	pF	V=0, f=1MHz		
Response Time (Rise)	t _r	-	3	18	μs	V _{CE} =2V, I _C =2mA R _L =100Ω	3	
Response Time (Fall)	t _f	-	4	18	μs		3	
Cut-off Frequency	f _c	-	80	-	kHz	V _{CE} =2V, I _C =2mA R _L =100Ω,-3dB	4	

Note 3. Fig.12&13

Note 4. Fig.14

CHARACTERISTIC CURVES

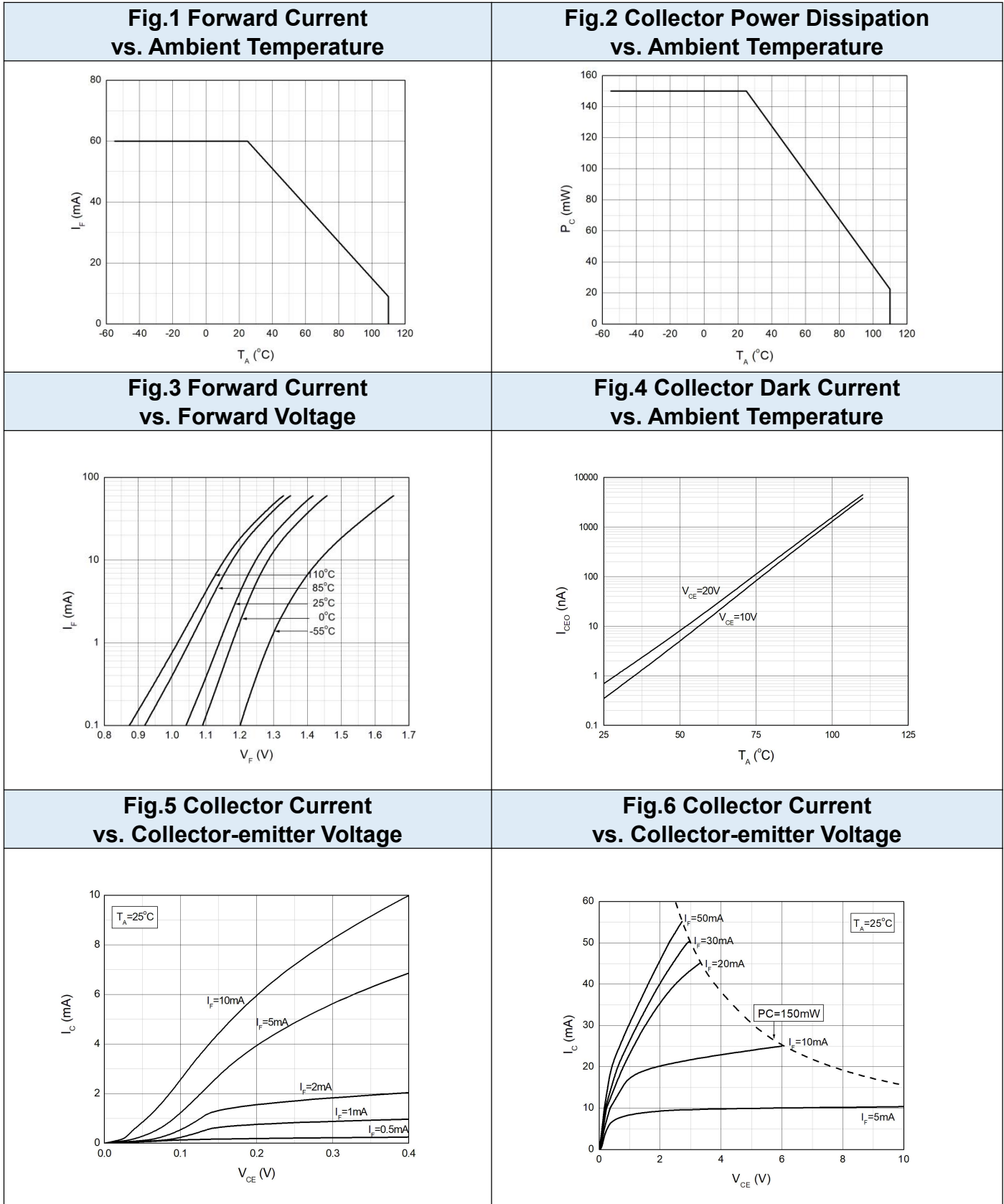

Fig.7 Normalized Current Transfer Ratio vs. Forward Current

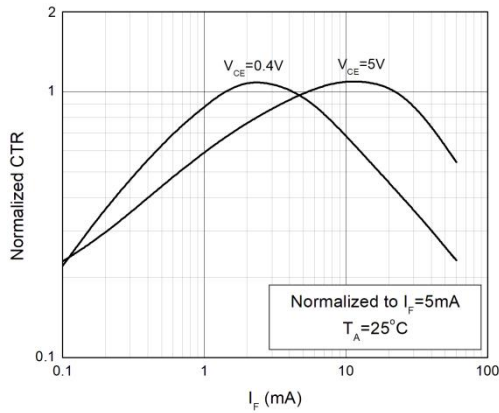

Fig.8 Normalized Current Transfer Ratio vs. Ambient Temperature

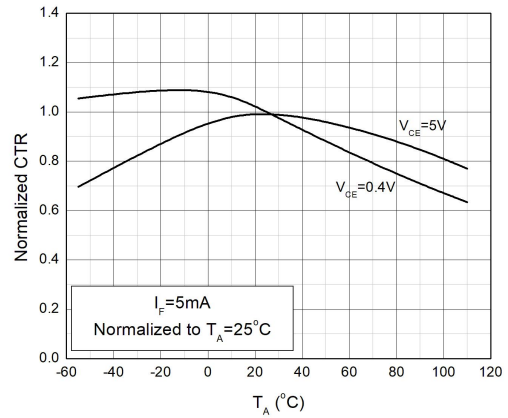

Fig.9 Collector-emitter Saturation Voltage vs. Ambient Temperature

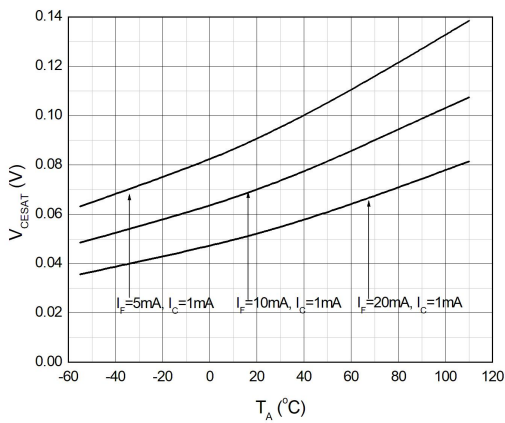

Fig.10 Switching Time vs. Load Resistance

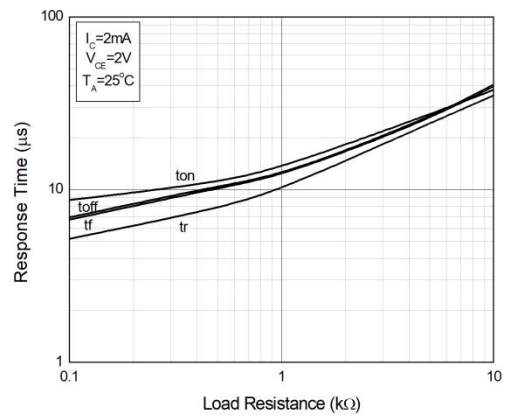
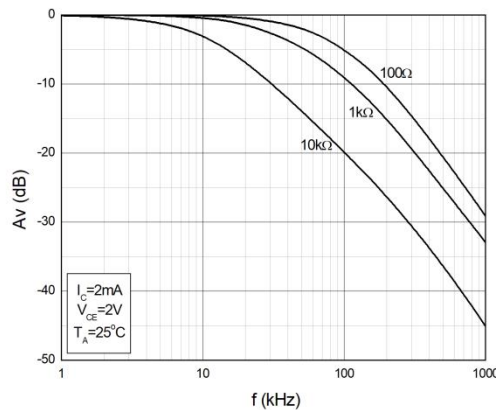
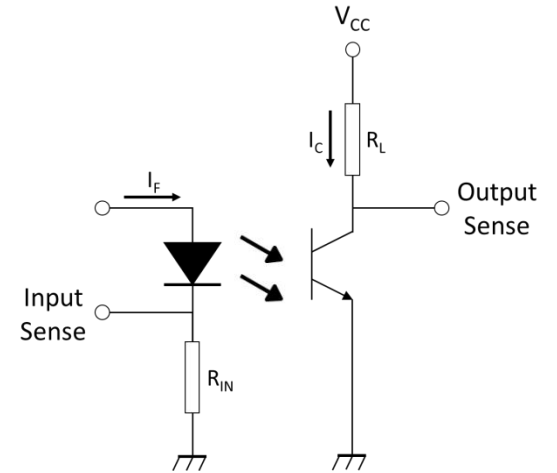
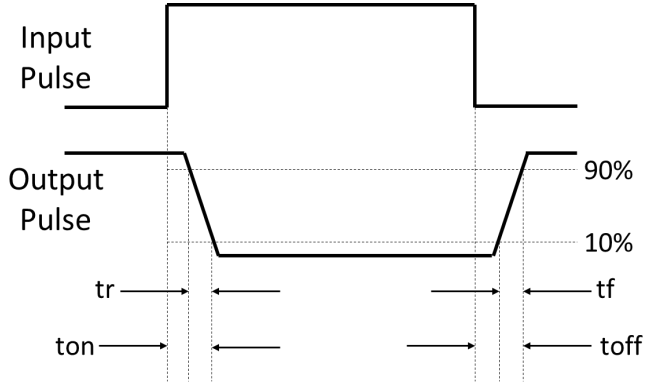
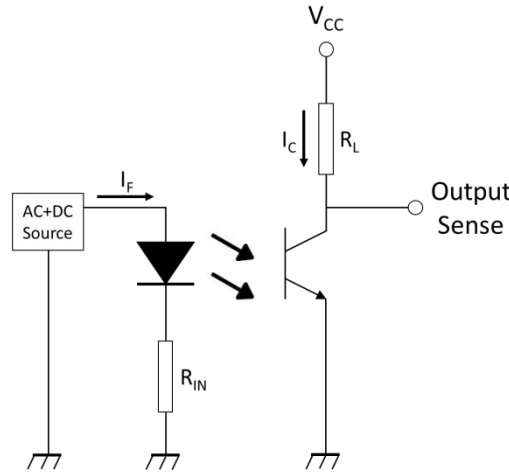

Fig.11 Frequency Response



TEST CIRCUITS

Fig.12 Test Circuits of Response Time	Fig.13 Curves of Response Time
	
Fig.14 Test Circuits of Frequency Response	
	

PACKAGE DIMENSIONS

Surface Mount (Low Profile) - (SOP4-SL)

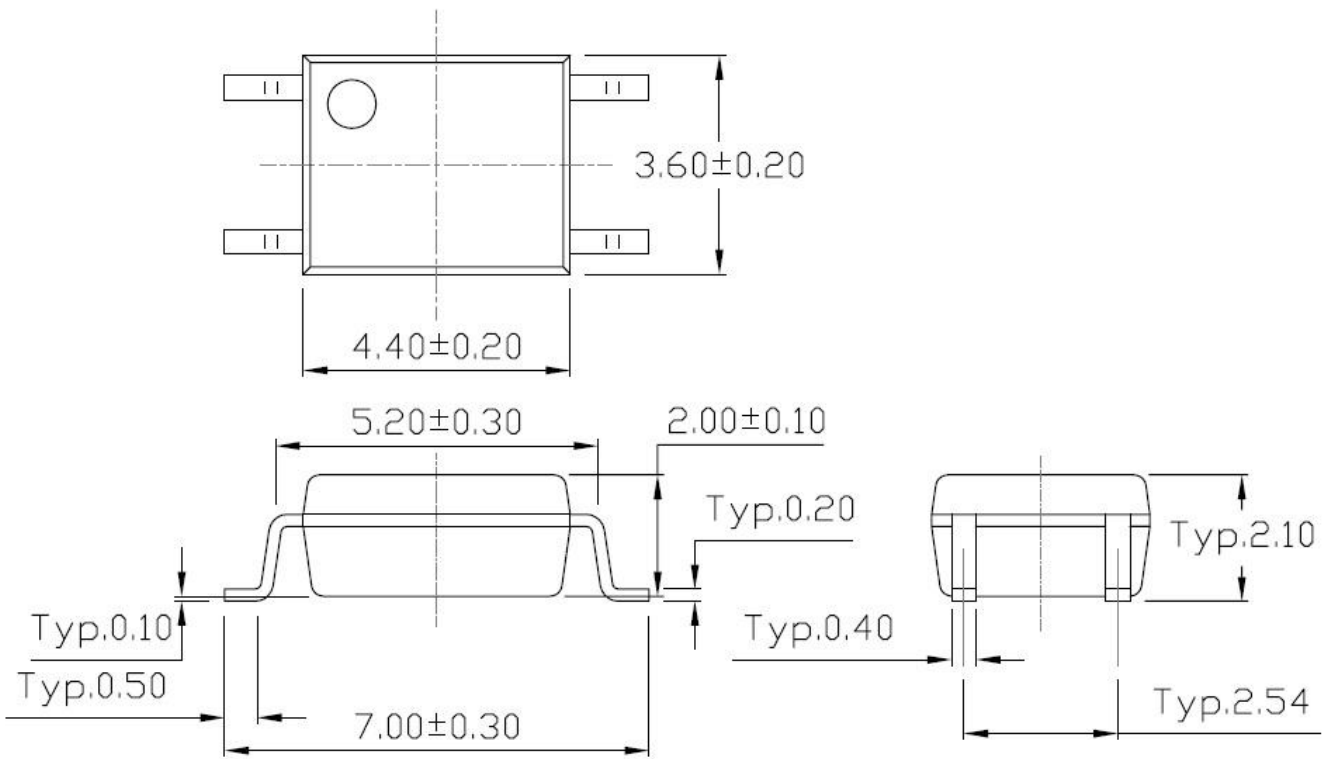

- Dimensions in mm unless otherwise stated

RECOMMENDED SOLDER MASK

Surface Mount (Low Profile) Lead Forming

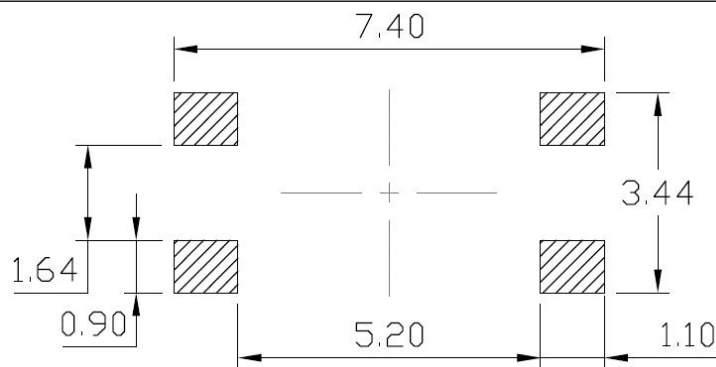

- Dimensions in mm unless otherwise stated

CARRIER TAPE SPECIFICATIONS

Option SOP4

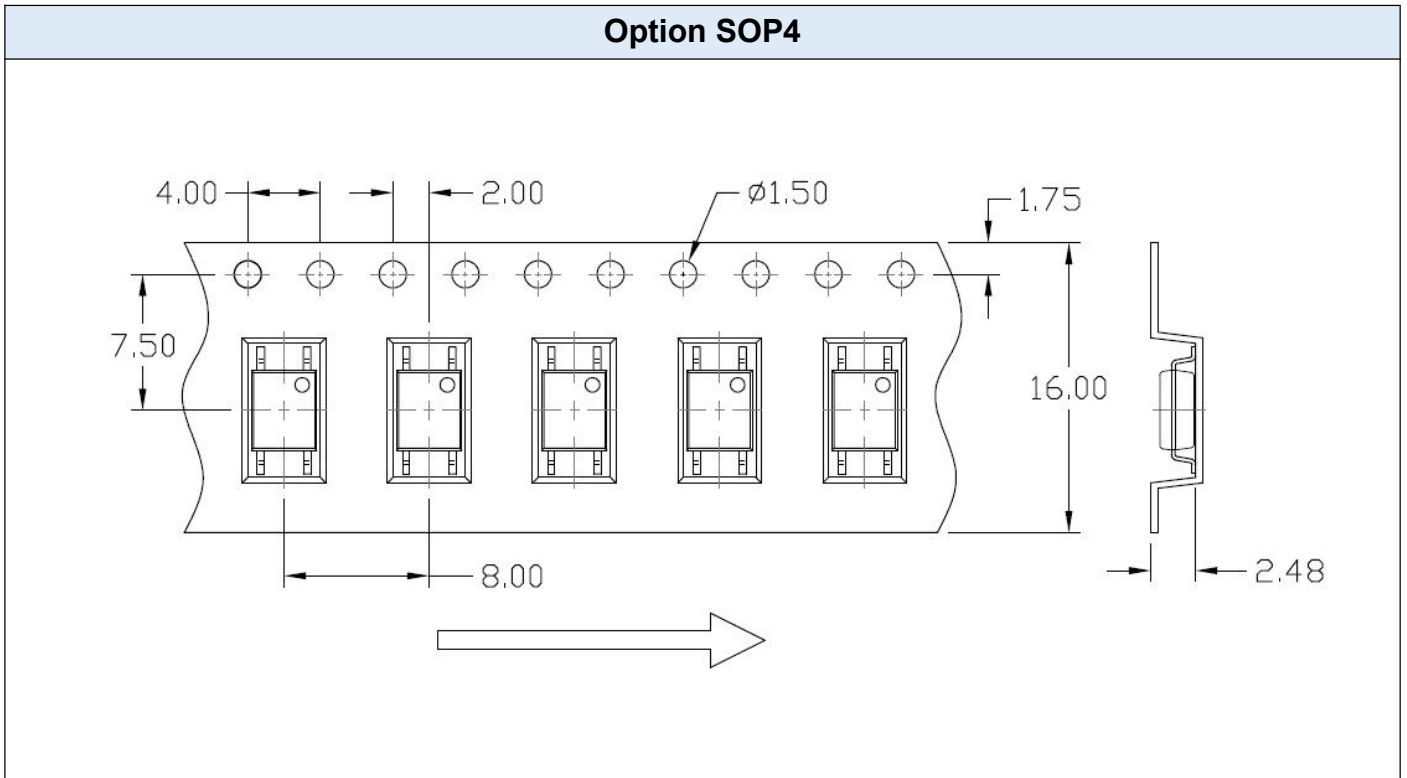

- Dimensions in mm unless otherwise stated

ORDERING AND MARKING INFORMATION

Marking Information	
	<p>ICPL : Company Abbr. 357 : Part Number X : CTR Rank / : ISOMICRON YY : Fiscal Year WW : Work Week A : Manufacturing Code</p>

Order Code	
<p>ICPL - 357 - 5 0 X E</p>	<p>Company Abbr. ← ICPL</p> <p>Part Number ← 357</p> <p>Lead Forming ← 5 5: SM-SL</p> <p>Halogen Free: E: Halogen-free, Lead-free Z: Halogen, Lead-free</p> <p>CTR Rank: A/B/C; None: 0</p> <p>Performance 0: Normal 1: Enhanced 2: Industrial level 3: Auto level 4: Military level</p>

Packing Quantity			
Option	Quantity	Quantity – Inner box	Quantity – Outer box
SM-SL	3000 Units/Reel	2 Reels/Inner box	5 Inner box/Outer box = 30k Units

REFLOW INFORMATION

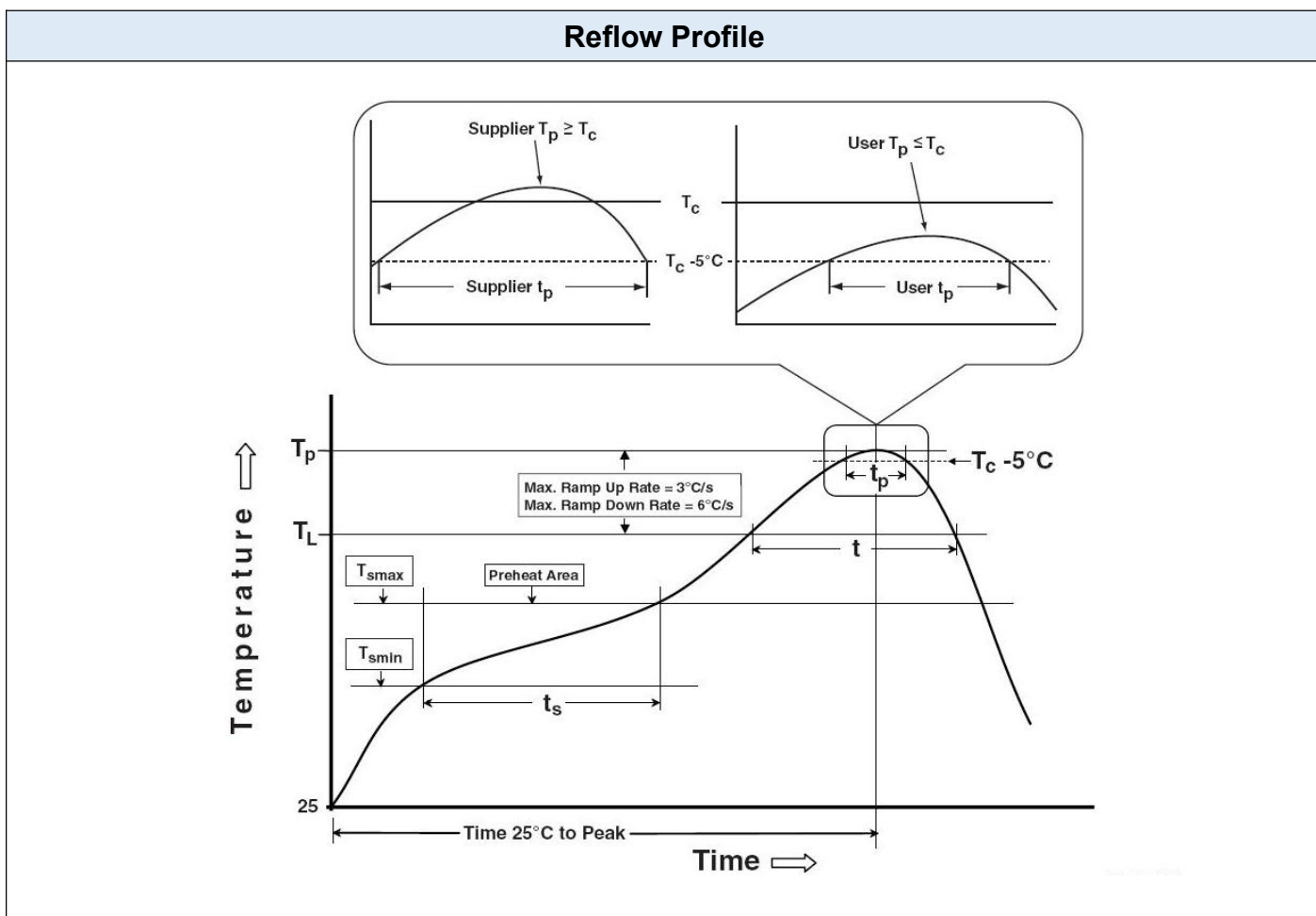

Profile Feature	Sn-Pb Assembly Profile	Pb-Free Assembly Profile
Temperature Min. (T _{smin})	100	150°C
Temperature Max. (T _{smax})	150	200°C
Time (t _s) from (T _{smin} to T _{smax})	60-120 seconds	60-120 seconds
Ramp-up Rate (t _L to t _P)	3°C/second max.	3°C/second max.
Liquidous Temperature (T _L)	183°C	217°C
Time (t _L) Maintained Above (T _L)	60 – 150 seconds	60 – 150 seconds
Peak Body Package Temperature	235°C +0°C / -5°C	260°C +0°C / -5°C
Time (t _P) within 5°C of 260°C	20 seconds	30 seconds
Ramp-down Rate (T _P to T _L)	6°C/second max	6°C/second max
Time 25°C to Peak Temperature	6 minutes max.	8 minutes max.

TEMPERATURE PROFILE OF SOLDERING

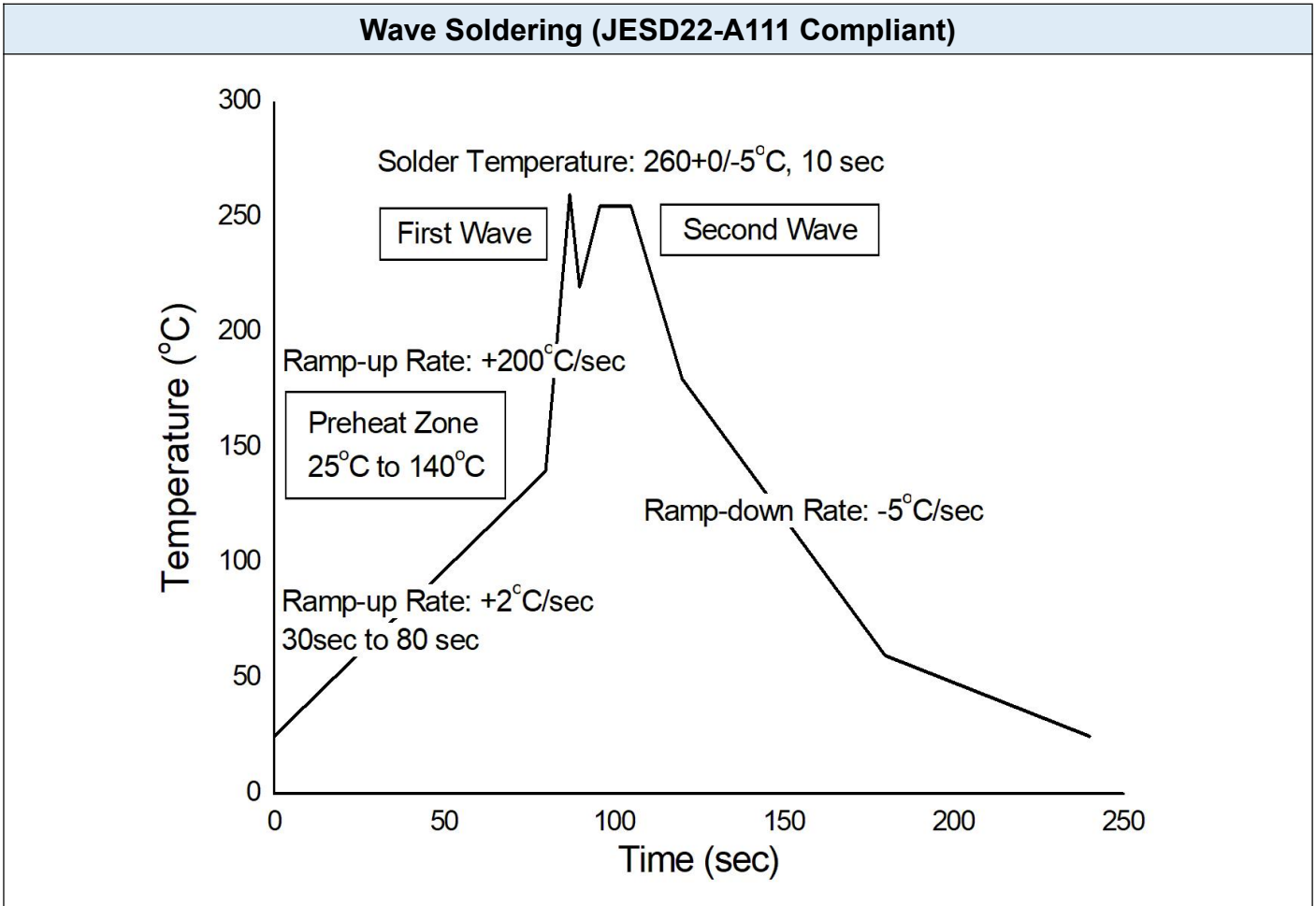

Hand Soldering By Soldering Iron	
Soldering Temperature	380+0/-5°C
Soldering Time	3 sec max.

- One time soldering is recommended for all soldering method.
- Do not solder more than three times for IR reflow soldering.

DISCLAIMER

- ISOMICRON is continually improving the quality, reliability, function and design. ISOMICRON reserves the right to make changes without further notices.
- The characteristic curves shown in this datasheet are representing typical performance which are not guaranteed.
- ISOMICRON makes no warranty, representation or guarantee regarding the suitability of the products for any particular purpose or the continuing production of any product. To the maximum extent permitted by applicable law, ISOMICRON disclaims (a) any and all liability arising out of the application or use of any product, (b) any and all liability, including without limitation special, consequential or incidental damages, and (c) any and all implied warranties, including warranties of fitness for particular
- The products shown in this publication are designed for the general use in electronic applications such as office automation, equipment, communications devices, audio/visual equipment, electrical application and instrumentation purpose, non-infringement and merchantability.
- This product is not intended to be used for military, aircraft, automotive, medical, life sustaining or lifesaving applications or any other application which can result in human injury or death.
- Please contact ISOMICRON sales agent for special application request.
- Immerge unit's body in solder paste is not recommended.
- Parameters provided in datasheets may vary in different applications and performance may vary over time. All operating parameters, including typical parameters, must be validated in each customer application by the customer's technical experts. Product specifications do not expand or otherwise modify ISOMICRON's terms and conditions of purchase, including but not limited to the warranty expressed therein.
- Discoloration might be occurred on the package surface after soldering, reflow or long-time use. It neither impacts the performance nor reliability.